

Single-phase Top/Bottom Terminal SSR with Integrated Heatsink [Current Input Type]



SRH1 Series CATALOG

For your safety, read and follow the considerations written in the instruction manual, other manuals and Autonics website.

The specifications, dimensions, etc. are subject to change without notice for product improvement. Some models may be discontinued without notice.

Features

- High heat dissipation efficiency with ceramic PCB and integrated heatsink
- Input Indicator (green)
- DIN rail mount or panel mount installation
- Phase control (power equality division/phase equality division), cycle control (fixed cycle/variable cycle)
- Improved dielectric strength: 4,000 VAC~

Ordering Information

This is only for reference, the actual product does not support all combinations. For selecting the specified model, follow the Autonics website.

SRH1 - A ① ② ③ - N

① Rated load voltage

2: 100 - 240 VAC~
4: 200 - 480 VAC~

② Rated load current

Number: Rated load current (unit: A)

③ Function

No-mark: Zero cross turn-on
R: Random turn-on

Product Components

- Product
- Instruction manual

Specifications

Input

Rated input current	4 - 20 mA
Allowable input voltage range	50 mA
Pick-up current	≥ 4.2 mA
Static off current	≤ 4.0 mA
Power factor	≥ 0.9 (difference between voltage phase and current phase: ≤ 25°)
Start-up time	60 Hz: 200 ms / 50 Hz: 250 ms
Operating time	60 Hz: 16.6 ms / 50 Hz: 20 ms
Operating mode ⁰¹⁾	Phase control (power equality division type / phase equality division type) Cycle control (variable cycle / fixed cycle)

01) You can change operation mode by jumper pin. Default is Phase control (power equality division type). For more information, see the 'Operation Mode'.

Output

Rated load voltage range	100 - 240 VACrms~ (50 / 60 Hz)			200 - 480 VACrms~ (50 / 60 Hz)		
Allowable load voltage range	90 - 264 VACrms~ (50 / 60 Hz)			200 - 528 VACrms~ (50 / 60 Hz)		
Rated load current	Resistive load (AC-51) ⁰¹⁾					
	20 Arms	30 Arms	60 Arms	20 Arms	30 Arms	60 Arms
Min. load current	0.5 Arms			0.5 Arms		
Max. 1 cycle surge current (60 Hz)	300 A	500 A	1000 A	300 A	500 A	1000 A
Max. non-repetitive surge current (I ² t, t = 8.3 ms)	350 A ² s	1000 A ² s	4000 A ² s	350 A ² s	1000 A ² s	4000 A ² s
Peak voltage (non-repetitive)	600 V			1000 V		
Leakage current (Ta = 25 °C)	≤ 10 mArms (240 VAC~/ 60 Hz)			≤ 10 mArms (480 VAC~/ 60 Hz)		
Output ON voltage drop [Vpk] (max. load current)	≤ 1.6 V					
Static off state dv/dt	500 V/μs					

01) AC-51 is utilization category at IEC60947-4-3.

General specifications

Output range (phase control)	0 - 99 %
Frequency reading function	YES
Dielectric strength (Vrms)	Input-output, input/output-case : 4000 VAC~ 50 / 60 Hz for 1 min
Insulation resistance	≥ 100 MΩ (500 VDC= megger)
Indicator	Input indicator (green)
Vibration	0.75 mm double amplitude at frequency of 10 to 55 Hz (for 1 min) in each X, Y, Z direction for 1 hour
Ambient temperature ⁰¹⁾	-20 to 70 °C, storage: -20 to 100 °C (no freezing or condensation)
Ambient humidity	45 to 85 %RH, storage: 45 to 85 %RH (no freezing or condensation)
Input terminal connection	≥ 1×0.5 mm ² (1×AWG 20), ≤ 1×16 mm ² (1×AWG 6) or ≤ 2×1.5 mm ² (2×AWG 16)
Output terminal connection ⁰²⁾	≥ 1×1.5 mm ² (1×AWG 16), ≤ 1×16 mm ² (1×AWG 6) or ≤ 2×6 mm ² (2×AWG 10)
Input terminal fixed torque	0.75 to 0.95 N m
Output terminal fixed torque	1.6 to 2.2 N m
Approval	CE, UL, ENEC
Weight	Rated load current 20 / 30 A: ≈ 410 g Rated load current 60 A: ≈ 680 g

01) See the 'SSR Derating Curve' in the product manual because the capacity of the rated load current is differ depending on the ambient temperature.

02) Connect the wire met the capacity of the load current to the output terminal.

Dimensions

- Unit: mm, For the detailed drawings, follow the Autonics website.

A Input indicator (green)

- When installing to the panel, tightening the screw with a torque of 1.8 to 2.5 N m.

Rated load current 20 / 30 A

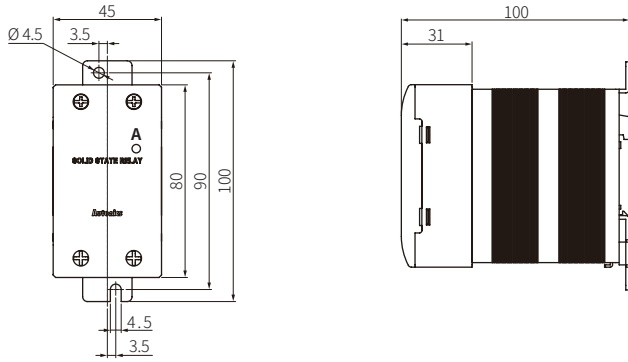

Rated load current 60 A

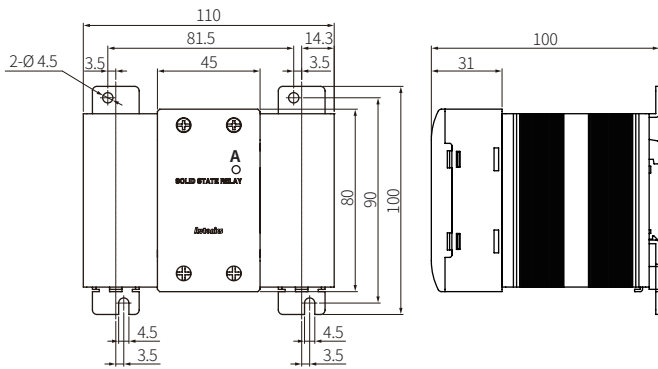

Panel cut-out

- Rated load current 20 / 30 A

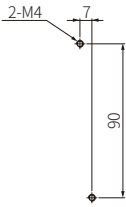

- Rated load current 60 A

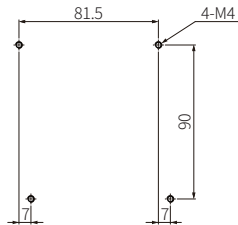

SSR Derating Curve

- Be aware that the ambient temperature and the derating curve is different by the rated input voltage when using the product.
- ⚠ Since the effectiveness of the heat radiation is decreased when SSRs are installed closely, be sure to supply less than 50 % of the rated load current.
- SSR derating curves obtained approval from the UL certification authority.

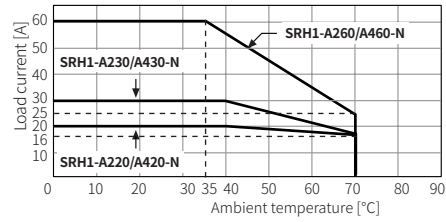

Operation Mode

Phase control

- Output waveform of phase control

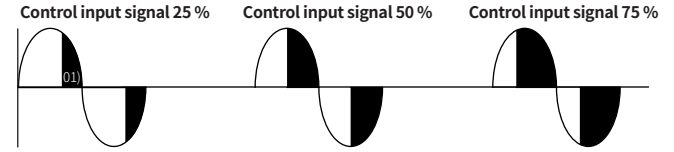

01) The output capacity on the load.

- Power equality division type : controls the output power which is proportional to the control input (4 - 20 mA) level.

- Phase equality division type : controls the phase angle which is proportional to the control input (4 - 20 mA) level.

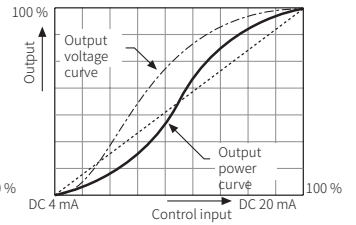
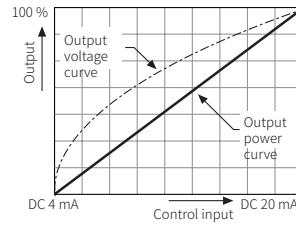

Cycle control

- Fixed cycle : controls continuously the number of full cycle which is supplied to load every 1 sec by being proportional to the control input (4 - 20 mA).

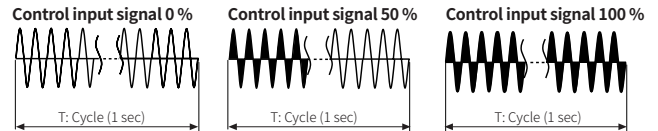

- Variable cycle

- : controls fast and accurately the subject with optimized the number of AC voltage cycle which is supplied to load by being proportional to the control input (4-20 mA).

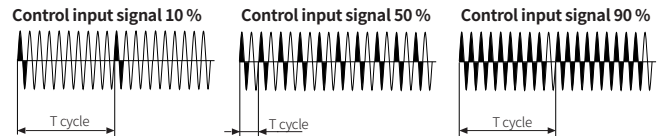

Detach front cover

Press the front cover connections (4 parts) at the right and left side with (-) driver, and front cover is detached.

- ⚠ Before detaching the front cover, be sure to cut off the load current and input.

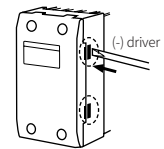

Jumper pin setting

The operation mode is changed by the jumper position. After changing the operation mode, supply the input signal again.

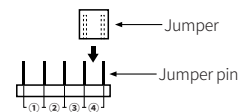
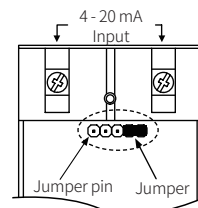

① CYCLE-V	Cycle control (variable cycle)
② CYCLE-F	Cycle control (fixed cycle)
③ PHASE-AD	Phase control (phase equality division type)
④ PHASE-PD (default)	Phase control (power equality division type)