

Rectangular Inductive Proximity Sensors (□ 8/12/50 mm)

PS Series (DC 3-wire) INSTRUCTION MANUAL

TCD210178AD

Autonics

Thank you for choosing our Autonics product.

Read and understand the instruction manual and manual thoroughly before using the product.

For your safety, read and follow the below safety considerations before using.

For your safety, read and follow the considerations written in the instruction manual, other manuals and Autonics website.

Keep this instruction manual in a place where you can find easily.

The specifications, dimensions, etc. are subject to change without notice for product improvement. Some models may be discontinued without notice.

Follow Autonics website for the latest information.

Safety Considerations

- Observe all 'Safety Considerations' for safe and proper operation to avoid hazards.
- ⚠ symbol indicates caution due to special circumstances in which hazards may occur.

⚠ Warning Failure to follow instructions may result in serious injury or death.

01. Fail-safe device must be installed when using the unit with machinery that may cause serious injury or substantial economic loss. (e.g. nuclear power control, medical equipment, ships, vehicles, railways, aircraft, combustion apparatus, safety equipment, crime/disaster prevention devices, etc.)
Failure to follow this instruction may result in personal injury, economic loss or fire.

02. Do not use the unit in the place where flammable/explosive/corrosive gas, high humidity, direct sunlight, radiant heat, vibration, impact, or salinity may be present.
Failure to follow this instruction may result in explosion or fire.

03. Do not disassemble or modify the unit.
Failure to follow this instruction may result in fire.

04. Do not connect, repair, or inspect the unit while connected to a power source.
Failure to follow this instruction may result in fire.

05. Check 'Connections' before wiring.
Failure to follow this instruction may result in fire.

⚠ Caution Failure to follow instructions may result in injury or product damage.

01. Use the unit within the rated specifications.

Failure to follow this instruction may result in fire or product damage.

02. Use a dry cloth to clean the unit, and do not use water or organic solvent.
Failure to follow this instruction may result in fire.

Cautions during Use

- Follow instructions in 'Cautions during Use'.
- Otherwise, it may cause unexpected accidents.
- 12 - 24 VDC power supply should be insulated and limited voltage/current or Class 2, SELV power supply device.
- Use the product, after 0.8 sec of supplying power.
- Wire as short as possible and keep away from high voltage lines or power lines, to prevent surge and inductive noise.
- Do not use near the equipment which generates strong magnetic force or high frequency noise (transceiver, etc.).
- In case installing the product near the equipment which generates strong surge (motor, welding machine, etc.), use diode or varistor to remove surge.
- This unit may be used in the following environments.
 - Indoors (in the environment condition rated in 'Specifications')
 - Altitude max. 2,000 m
 - Pollution Degree 2
 - Installation Category II

Cautions for Installation

- Install the unit correctly with the usage environment, location, and the designated specifications.
- Do NOT impacts with a hard object or excessive bending of the wire lead-out. It may cause damage the water resistance.
- Do NOT pull the \varnothing 2.5 mm cable with a tensile strength of 20 N, the \varnothing 4 mm cable with a tensile strength of 30 N or over and the \varnothing 5 mm cable with a tensile strength of 50 N or over. It may result in fire due to the broken wire.
- When extending wire, use AWG 22 cable or over within 200 m.
- Refer to the table below for the screw tightening torque when mounting the bracket.

Sensing side length	8 mm	12 mm	50 mm
Tightening torque	0.3 N m	0.49 N m	0.98 N m

Ordering Information

This is only for reference, the actual product does not support all combinations. For selecting the specified model, follow the Autonics website.

PS ① - ② D ③ ④

① Sensing side length
Number: Side length of head (unit: mm)

② Sensing distance
Number: Sensing distance (unit: mm)

③ Control output
N: NPN Normally Open
N2: NPN Normally Closed
P: PNP Normally Open
P2: PNP Normally Closed

④ Sensing side
No-mark: Standard type
U: Upper side type

Product Components

Sensing side length	8 mm	12 mm	50 mm
Bracket	1 ×	1 ×	-
Bolt	M3 × 1	M3 × 2	M4 × 4
Nut	M3 × 1	M3 × 2	-
Spring washer	1 ×	-	-
Flat washer	1 ×	-	-

Connections

■ Cable type

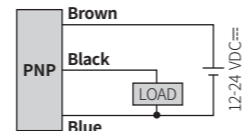
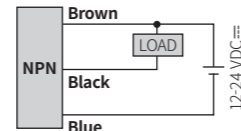

■ Control Output Circuit (NPN output)

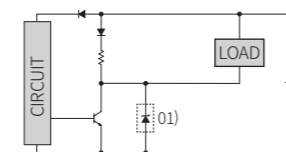

■ Control Output Circuit (PNP output)

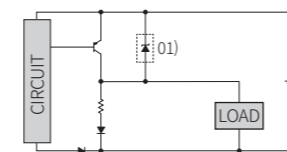

01) Sensing side length 8 mm: except zener diode

Operation Timing Chart

	Normally Open	Normally Closed
Sensing target	Presence Nothing	Presence Nothing
Load	Operation Return	Operation Return
Output voltage	NPN output H L	H L
	PNP output H L	H L
Operation indicator (red)	ON OFF	ON OFF

Specifications

Installation	Standard type / Upper side type		
Model	PS08-2.5D □-□	PS12-4D □-□	PS50-30D □
Sensing side length	8 mm	12 mm	50 mm
Sensing distance	2.5 mm	4 mm	30 mm
Setting distance	0 to 1.75 mm	0 to 2.8 mm	0 to 21 mm
Hysteresis	≤ 10 % of sensing distance (sensing side length 8 mm: ≤ 20 %)		
Standard sensing target: iron	8 × 8 × 1 mm	12 × 12 × 1 mm	90 × 90 × 1 mm
Response frequency 01)	1 kHz	500 Hz	50 Hz
Affection by temperature	≤ ± 10 % for sensing distance at ambient temperature 20 °C (sensing side length 8 mm: ≤ ± 15 %)		
Indicator	Operating indicator (red)		
Approval	CE ENEC	CE ENEC	CE ENEC
Unit weight (package)	≈ 16 g (≈ 30 g)	≈ 62 g (≈ 77 g)	≈ 220 g (≈ 256 g)

01) The response frequency is the average value. The standard sensing target is used and the width is set as 2 times of the standard sensing target, 1/2 of the sensing distance for the distance.

Power supply	12 - 24 VDC (ripple P-P: ≤ 10 %), operating voltage: 10 - 30 VDC
Current consumption	≤ 10 mA
Control output	Sensing side length 8 mm: ≤ 100 mA Sensing side length 12 mm, 50 mm: ≤ 200 mA
Residual voltage	Sensing side length 8 mm: ≤ 1.0 V Sensing side length 12 mm, 50 mm: ≤ 1.5 V
Protection circuit	Surge protection circuit, output short over current protection circuit, reverse polarity protection
Insulation resistance	≥ 50 MΩ (500 VDC megger)
Dielectric strength	Between all terminals and case: 1,500 VAC ~ 50 / 60Hz for 1 minute (sensing side length 8 mm - between all terminals and case: 1,000 VAC ~ 50 / 60Hz for 1 minute)
Vibration	1 mm double amplitude at frequency 10 to 55 Hz in each of X, Y, Z directions for 2 hours
Shock	500 m/s ² (≈ 50 G) X, Y, Z directions for 3 times
Ambient temp.	-25 to 70 %RH, storage: -30 to 80 %RH (no freezing or condensation)
Ambient humi.	35 to 95 %RH, storage: 35 to 95 %RH (no freezing or condensation)
Protection rating	IP67 (IEC standards)
Connection	Cable type
Cable spec.	Sensing side length 8 mm: \varnothing 2.5 mm, 3-wire, 1 m Sensing side length 12 mm: \varnothing 4 mm, 3-wire, 2 m Sensing side length 50 mm: \varnothing 5 mm, 3-wire, 2 m
Wire spec.	\varnothing 2.5 mm cable : AWG 28 (0.08 mm, 19-core), insulator diameter: \varnothing 0.9 mm \varnothing 4 mm, \varnothing 5 mm cable : AWG 22 (0.08 mm, 60-core), insulator diameter: \varnothing 1.25 mm
Material	Sensing side length 8 mm Case: PC, Sensing side length 12 mm Case: Heat-resistant ABS, Sensing side length 50 mm Case: PBT, standard cable (black): polyvinyl chloride (PVC)

Dimensions

• Unit: mm, For the detailed dimensions of the product, follow the Autonics web site.

A Operation indicator (red) **B** Tap hole

■ PS08

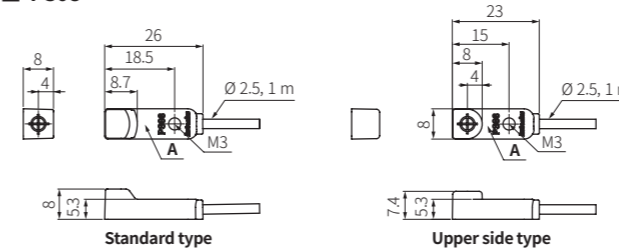

• Bracket

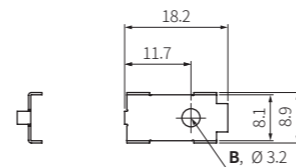

• Mounting hole cut-out

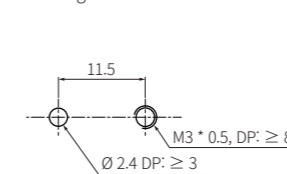

■ PS12

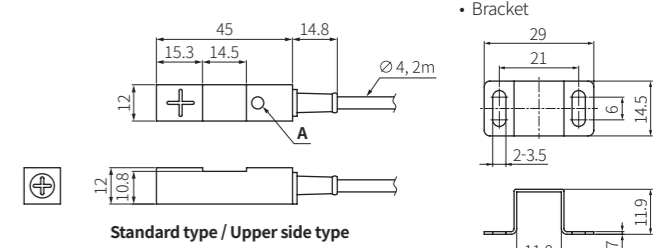

■ PS50

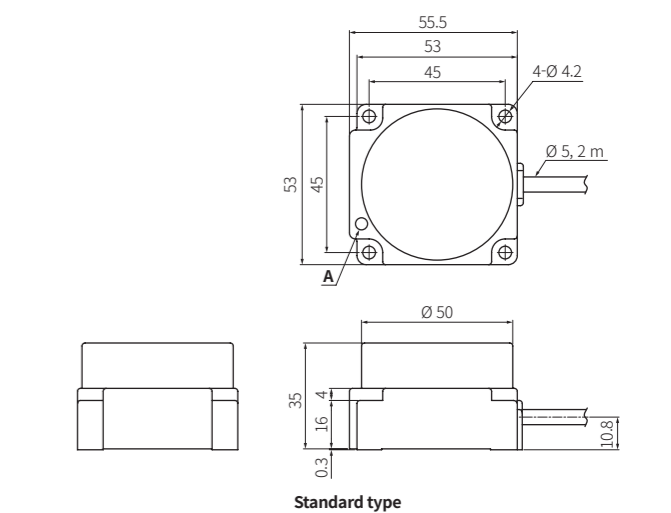

Setting Distance Formula

Detecting distance can be changed by the shape, size or material of the target.

For stable sensing, install the unit within the 70 % of sensing distance.

Setting distance (Sa)
= Sensing distance (Sn) × 70 %

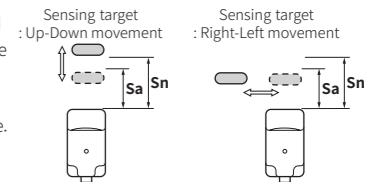

Mutual-interference & Influence by Surrounding Metals

■ Mutual-interference

When plural proximity sensors are mounted in a close row, malfunction of sensor may be caused due to mutual interference.

Therefore, be sure to provide a minimum distance between the two sensors, as below table.

[Face to Face]

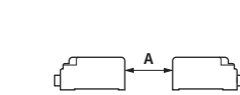

[Parallel]

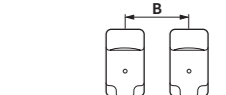

■ Influence by surrounding metals

When sensors are mounted on metallic panel, it must be prevented sensors from being affected by any metallic object except target. Therefore, be sure to provide a minimum distance as below chart.

• Standard type

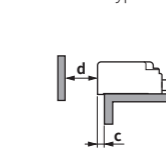

• Upper side type

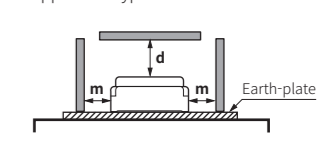

(unit: mm)

Sensing side length	8 mm	12 mm	50 mm
A	16	24	180
B	16	24	130
c	3	5	-
d	15	12	120
m	8	12	50