

2D 270° Laser Scanners

LSC Series

INSTRUCTION MANUAL

TCD210228AH

Autonics

Thank you for choosing our Autonics product.

Read and understand the instruction manual and manual thoroughly before using the product.

For your safety, read and follow the below safety considerations before using.

For your safety, read and follow the considerations written in the instruction manual, other manuals and Autonics website.

Keep this instruction manual in a place where you can find easily.

The specifications, dimensions, etc. are subject to change without notice for product improvement. Some models may be discontinued without notice.

Follow Autonics website for the latest information.

Safety Considerations

- Observe all 'Safety Considerations' for safe and proper operation to avoid hazards.
- ⚠ symbol indicates caution due to special circumstances in which hazards may occur.

⚠ Warning Failure to follow instructions may result in serious injury or death.

- 01. Fail-safe device must be installed when using the unit with machinery that may cause serious injury or substantial economic loss. (e.g. nuclear power control, medical equipment, ships, vehicles, railways, aircraft, combustion apparatus, safety equipment, crime / disaster prevention devices, etc.)**
Failure to follow this instruction may result in economic loss, personal injury or fire.
- 02. Do not use the unit in the place where flammable / explosive / corrosive gas, high humidity, direct sunlight, radiant heat, vibration, impact, or salinity may be present.**
Failure to follow this instruction may result in fire or explosion.

- 03. This product is not safety sensor and does not observe any domestic nor international safety standard.**
Do not use this product with the purpose of injury prevention or life protection, as well as in the place where economic loss may be expected.
- 04. Do not connect the unit while connected to a power source.**
Failure to follow this instruction may result in fire.

- 05. Check connections and connect cables.**
Failure to follow this instruction may result in fire.
- 06. Do not disassemble or modify the unit.**
Failure to follow this instruction may result in fire.

⚠ Caution Failure to follow instructions may result in injury or product damage.

- 01. Do not stare at the laser emitter.**
Failure to follow this instruction may result in eye damage.
- 02. Use the unit within the rated specifications.**
Failure to follow this instruction may result in fire or product damage.
- 03. Use dry cloth to clean the unit. Do not use water or organic solvent when cleaning the unit.**
Failure to follow this instruction may result in fire.
- 04. Do not apply high pressure to the laser scanner to clean it.**
- 05. As collision avoidance function for a moving object, set the field considering the speed of the moving object, the braking distance, and the response time of the laser scanner.**

Cautions during Use

- Follow instructions in 'Cautions during Use'. Otherwise, it may cause unexpected accidents.
- Power supply should be insulated and limited voltage / current or Class 2, SELV power supply device.
- After supplying power, the sensor performs self-check for about 10 sec. When self-checking, error occurrence, and teaching, the laser scanner outputs the same as it sensed obstacle.
- In order to avoid malfunction from static electricity or noise, ground shield wire of the power I/O cable or housing fixing screws.
- Mutual optical interference between laser scanners and photoelectric sensors may result in malfunction.
- Mutual optical interference between laser scanners may result in malfunction.
- Objects cannot be scanned when covering the front cover of the laser scanner.
- When the laser scanner is moved to another position, use it after re-teaching.
- Do not drop the unit. It may cause malfunction.
- Installing the laser scanner in the place where smoke, fog, dust, or corrosion is heavy may result in malfunction.
- Keep away from high voltage lines or power lines to prevent inductive noise. In case of installing power line and input signal line closely, use line filter or varistor at power line and shield wire at input signal line.
- Do not use the laser scanner near the equipment which generates strong magnetic force or high frequency noise.
- Cover with shields, hoods, or etc. to prevent direct incidence of strong light (direct rays of sunlight, incandescent) into the laser scanner beam spread angle.
- Fix the laser scanner in position with the fixing screw. Vibration may result in malfunction.

- When IP address of the laser scanner and wireless router is same, the communication does not connected. Set the wireless network (Wifi) to "Disable" in the network settings of the Windows operating system.
- This unit may be used in the following environments.
 - Indoors (in the environment condition rated in 'Specifications')
 - Altitude max. 2,000 m
 - Pollution degree 2
 - Installation category II

Ordering Information

This is only for reference, the actual product does not support all combinations. For selecting the specified model, follow the Autonics website.

LSC - C ① C T3 - ET

① Detection distance

Number: Detection distance (unit: m)

Product Components

- Product
- M3 × 8 mm bolt (SUS) × 4
- Instruction manual
- Connector cap × 1

Sold Separately

- Power I / O cable: CID-□-VG, CLD-□-VG
- Ethernet cable: C18-□-RA, C48-□-RA

Network Setting

- Configure the network settings of LiDAR sensor via atLiDAR.
- For initial IP address, refer to the table as below.

IP address	192.168.0.1
Subnet mask	255.255.255.0
Gateway	192.168.0.2

Connections

■ Power I / O connector wiring (M12 12-pin connector, Plug-Male)

Pin	Cable color	Signal	Function	Pin	Cable color	Signal	Function
1	Brown	+V	+V	7	Black	IN3	Choose a field set
2	Blue	GND	GND	8	Gray	IN2	
3	White	OUT2	Output when object is detected in subfield 2	9	Red	IN1	Output when object is detected in subfield 3
4	Green	OUT1	Output when object is detected in subfield 1	10	Purple	OUT3	
5	Pink	IN GND	IN GND	11	Gray / Pink	N.C	-
6	Yellow	IN4	Choose a field set	12	Red / Blue	OUT4	Ready / Error, Sync output

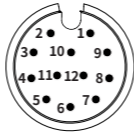

■ Ethernet connector wiring (M12 8-pin-RJ45 connector, Plug-Male)

M12 8-pin		RJ45	
Pin	Signal	Pin	Signal
6	RX+	1	TX+
4	RX-	2	TX-
5	TX+	3	RX+
8	TX-	6	RX-
1, 2, 3, 7	-	4, 5, 7, 8	-

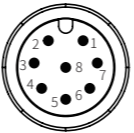

Input / Output Specifications

■ Input specifications

The input operates with rising / falling edge and H / L level and can be selected.

Input	Options	Descriptions
IN1	Select field set	-
IN2	Select field set	-
IN3 ⁰¹⁾	Select field set or Scan input	It can be used as scan start and stop signal.
IN4 ⁰¹⁾	Select field set or Teaching	It can be used as an external input signal for teaching.

01) Default: Select field set

■ Output specifications

The output operates at PNP / NPN and can be selected. RESTART sets to time.

Output	Descriptions
OUT1	Subfield 1 output
OUT2	Subfield 2 output
OUT3	Subfield 3 output
OUT4 ⁰¹⁾	Ready / Error output fixed Sync pulse output at 90°

01) Refer to the scan angle image in Cautions for installation.

Software

Download the installation file and the manuals from the Autonics website.

Supported devices are different for each software version.

■ atLiDAR (V2.0 or later)

atLiDAR is the management program for laser scanner parameter settings, status information and monitoring data, etc.

This program communicates with the laser scanner via Ethernet communication.

■ ROS driver package

This is a ROS driver package that helps to receive laser scanner information and set ROS (Robot Operating System) parameters without additional settings.

Dimensions

- Unit: mm, For the detailed drawings, follow the Autonics website.

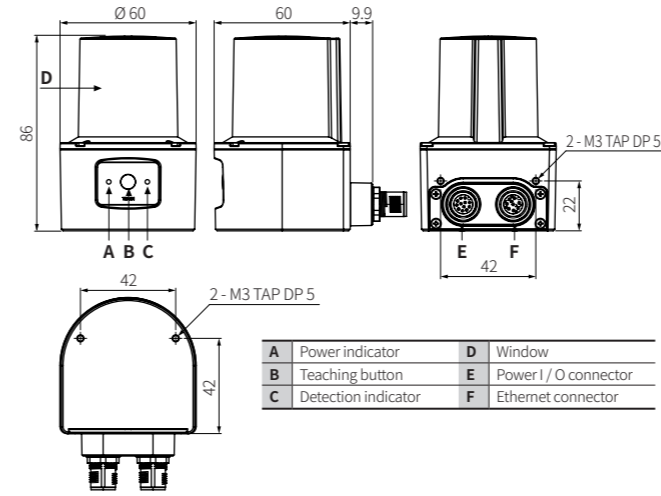

A	Power indicator	D	Window
B	Teaching button	E	Power I / O connector
C	Detection indicator	F	Ethernet connector

Circuit

■ Photocoupler input

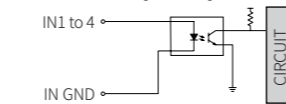

■ NPN open collector output

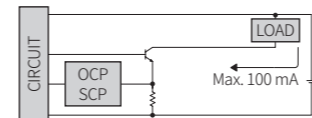

■ PNP open collector output

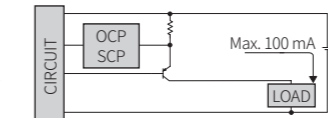

- OCP (over current protection), SCP (short circuit protection)
- If short-circuit the control output terminal or supply current over the rated specification, normal control signal is not output due to the output short over current protection circuit.

Installation Order

For details of atLiDAR settings, refer to the software manual.

- 01. Install the laser scanner.**
Secure the device to the installation location using four M3 × 8 mm bolts.
- 02. Install the laser scanner program to PC.**
Download the software provided by Autonics website.
- 03. Connect the laser scanner and the PC, and set the network.**
Refer to the Network Setting.
- 04. Laser scanner function setting**
Use atLiDAR, set each function to adequate the installation environment of the laser scanner and the obstacles to be detected.

Cautions for Installation

- Install the unit correctly with the usage environment, location, and the designated specifications.
- Impact with hard objects or excessive bending of the wire lead-out may result in damage on the waterproof function.
- Use this device after testing. Check if the indicator is working properly depending on whether the obstacle exists.
- Install the unit according to the direction you want to detect the object.

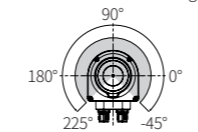

- To prevent mutual interference when installing multiple devices, refer to the below.

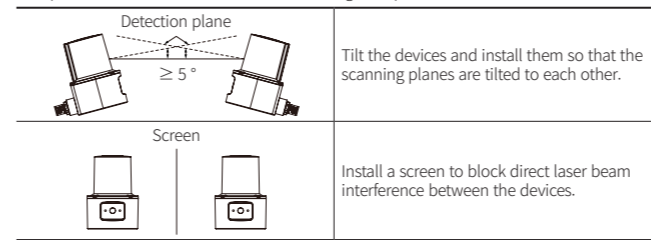

Manual

For proper use of the product, refer to the manuals and be sure to follow the safety considerations in the manuals.

Download the manuals from the Autonics website.

Indicators

Status	Indicator		Other description	
	Power (green)	Detection (red)		
Power on	Light on then off	-	When the power is applied normally, it turns off.	
Normal operation	ON	-	-	
ERROR	-	Flashing	-	
Obstacle detection	ON	ON	-	
Teaching	Step 1	Flashing ⁰¹⁾	-	Teaching preparation stage : Start teaching with the teaching button, IN4 signal or software.
	Step 2	Flashing ⁰²⁾	Flashing ⁰²⁾	Teaching progress stage : There must be no moving objects in the teaching area.
	Step 3	ON	-	Turns on after teaching is completed. (normal operation)
Apply parameters	Flashing (once)	Flashing (once)	Flashes during application of parameters set by software.	

01) Teaching preparation stage time selection among 5 / 10 / 15 sec by software

02) Teaching progress stage time selection among 10 / 20 / 30 / 40 / 50 / 60 sec by software

Specifications

Model	LSC-C5CT3-ET	LSC-C10CT3-ET	LSC-C25CT3-ET
Environment of use	Indoor		
Emitting property	Infrared laser		
Laser class	CLASS 1		
Wave length band	905 nm		
Max. pulse output power	6 W		
Beam conversion angle	9.5 mrad		
Scanning frequency	15 Hz		
Response time	Typ. 67 ms		
Detection distance range	0.05 to 5 m	0.05 to 10 m	0.05 to 25 m
Max. detection distance of 10 % reflector	5 m	8 m	
Detection distance error	System error: Typ. ± 60 mm, statistical error: Typ. 20 mm (1 σ)		
Min. object size ⁰¹⁾	At detection distance of 8 m: ≈ 121 mm		
Angular resolution	0.33°		
Aperture angle	270°		
Object reflectivity	> 4 %		
Number of field sets	16 (1 set: Consists of subfields 1, 2, 3)		
Number of field sets that can be used concurrently	1		
Unit weight (package)	≈ 228 g (314 g)		
Approval	CE, RoHS		

01) Even objects smaller than the set min. object size can be detected depending on the environment.

Power supply	9 - 28 VDC=
Power consumption ⁰¹⁾	< 4 W
Input	4 Photocoupler inputs H: ≥ 9 - 28 VDC=, L: ≤ 3 VDC=
Output signal	4: 3-output + 1-Ready / Error, Sync output NPN-PNP open collector output (software setting)
Load voltage	9 - 28 VDC=
Load current	≤ 100 mA
Residual voltage	≤ 3.0 VDC=
Insulation resistance	≥ 5 MΩ (500 VDC= megger)
Dielectric strength	500 VAC ~ 50 / 60 Hz for 1 minute
Vibration	10 sweep cycles in each X, Y, Z axes at sine wave, 10 to 500 Hz, acceleration 5 G
Vibration (malfunction)	10 minutes in each X, Y, Z axes at sine wave, 10 to 500 Hz, acceleration 5 G
Vibration (irregular)	5 hours in each X, Y, Z axes at 5 to 250 Hz, 42.4 m/s ² RMS
Shock	3 times in each X, Y, Z axes at sine half wave, acceleration 50 G, duration 11 ms 1000 times in each X, Y, Z axes at sine half wave, acceleration 25 G, duration 6 ms 5000 times in each X, Y, Z axes at sine half wave, acceleration 50 G, duration 3 ms
Shock (malfunction)	6 times in each X, Y, Z axes at sine half wave, acceleration 50 G, duration 11 ms
Ambient illuminance	≤ 80,000 lx
Ambient temperature	-10 to 50 °C, storage: -30 to 70 °C (no freezing or condensation)
Ambient humidity	0 to 95 %RH, storage: 0 to 95 %RH (no freezing or condensation)
Protection structure	IP67 (IEC standard)
Connector specification	Power I / O: M12 12-pin, Ethernet: M12 8-pin
Material	Case: AL, Window: PC

01) Excluding power supplied to the load

Communication Interface

■ Ethernet

Communication protocol	TCP/IP
Communication speed	100BASE-TX
Baud rate	100 Mbps